

SHORELINE SHORTS

© 2021 Peak Media Properties, LLC.

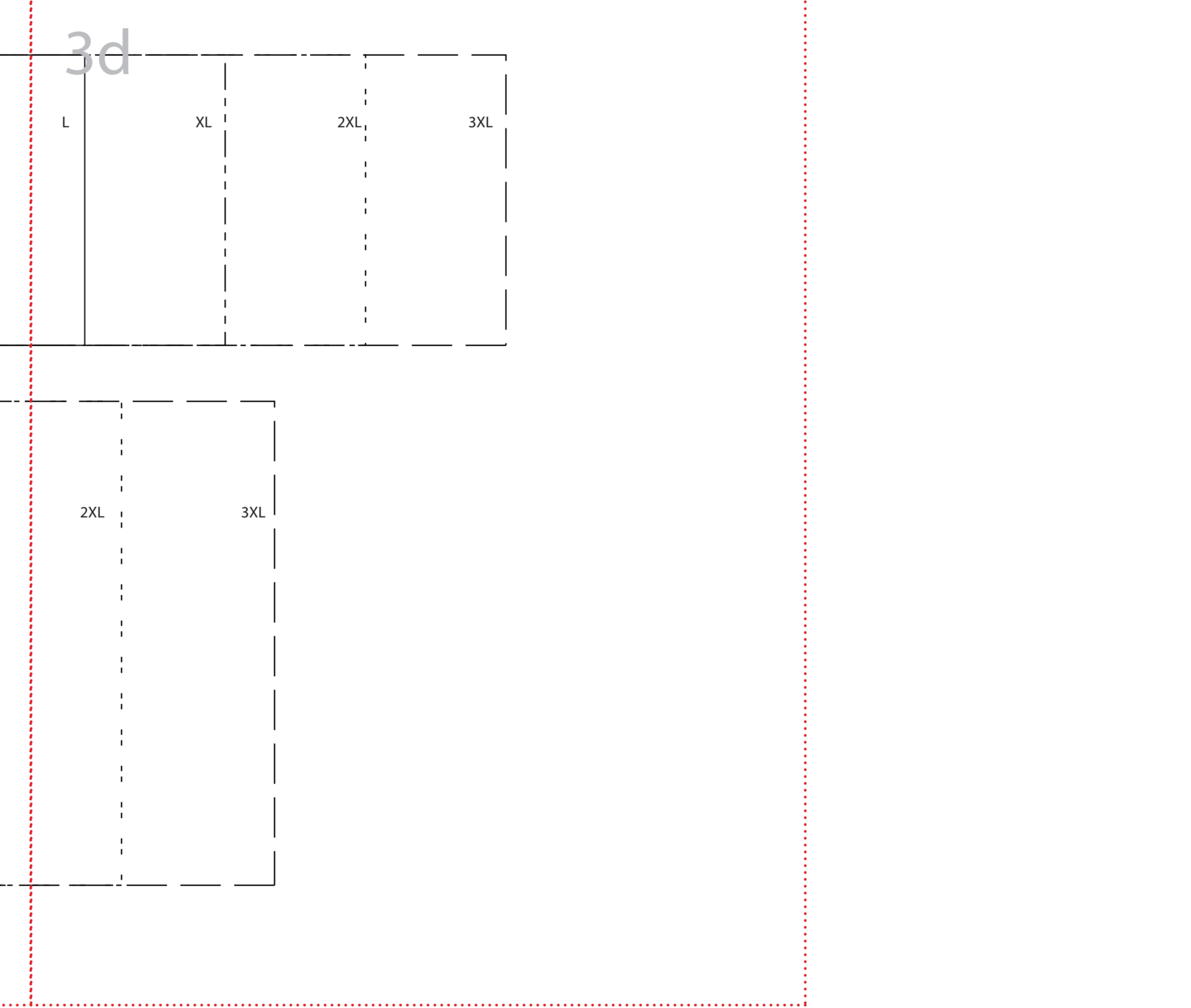
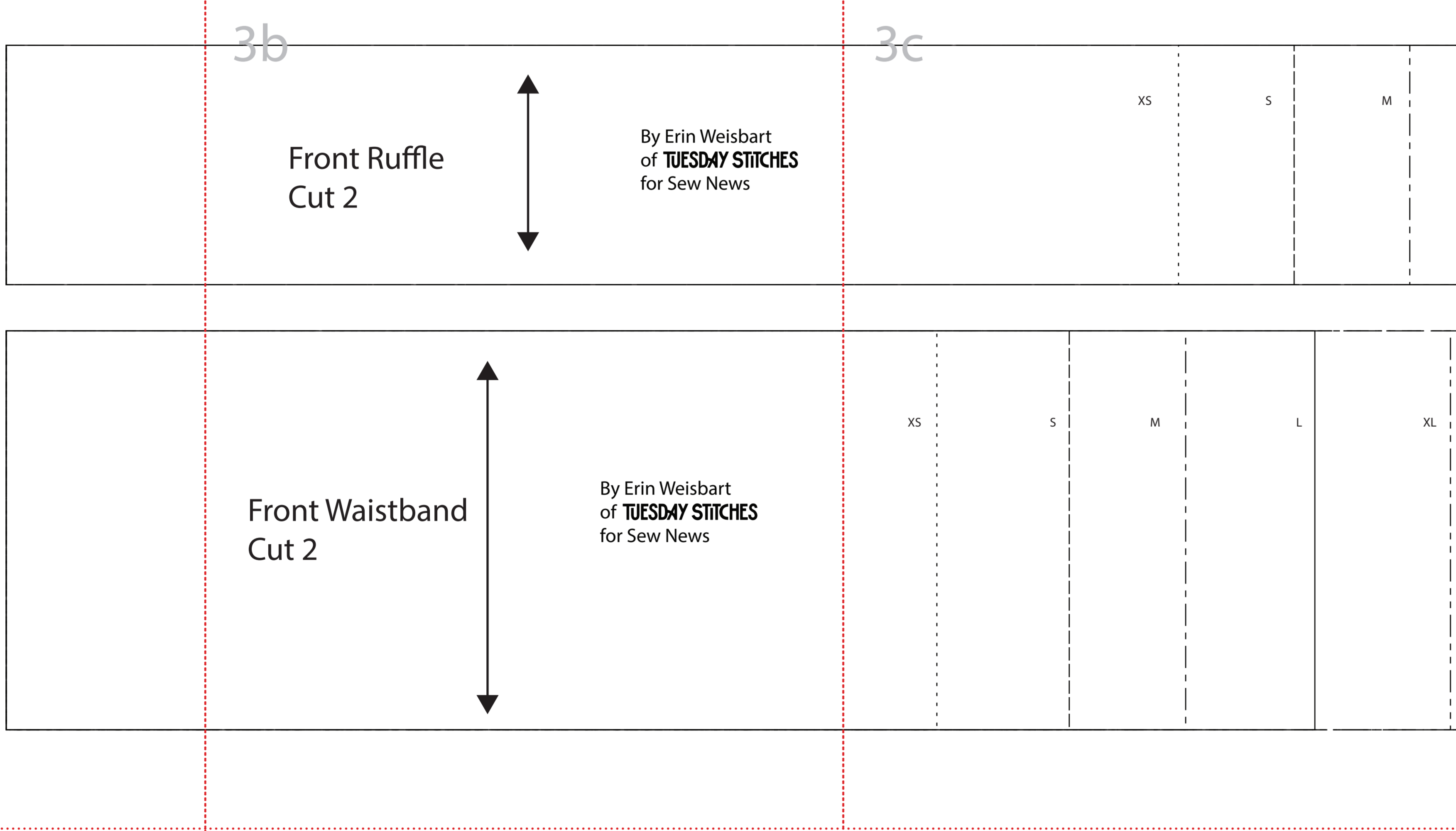
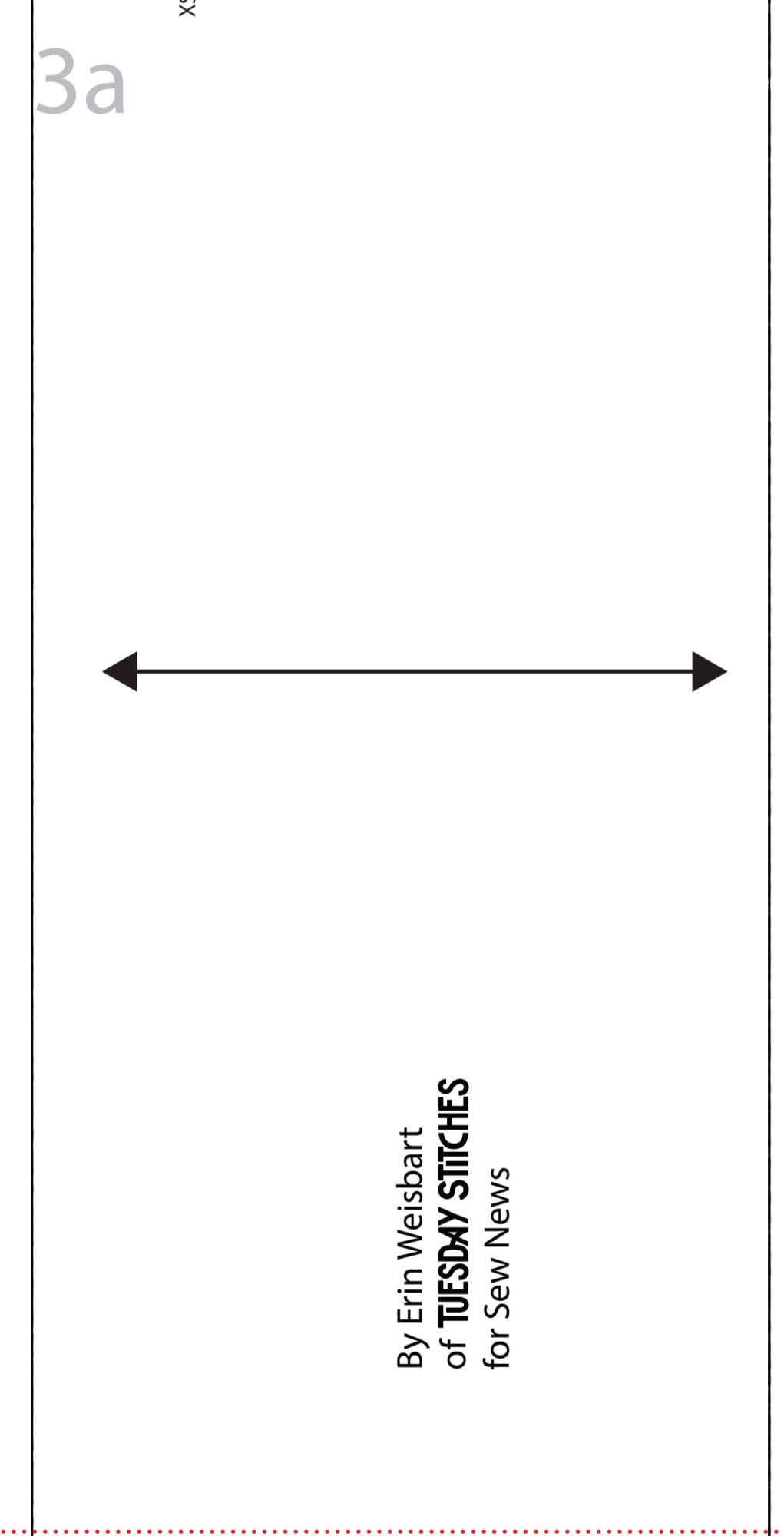
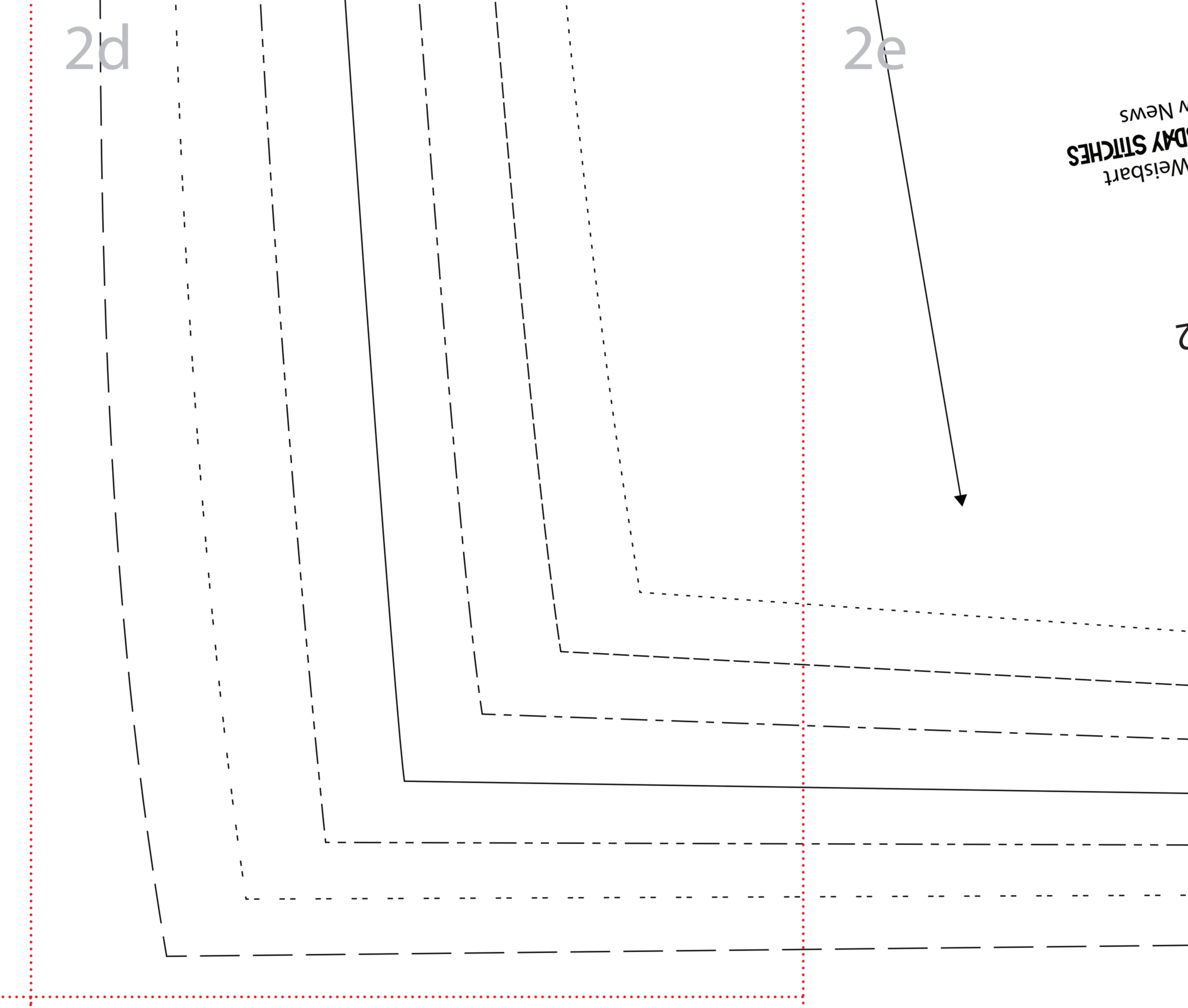
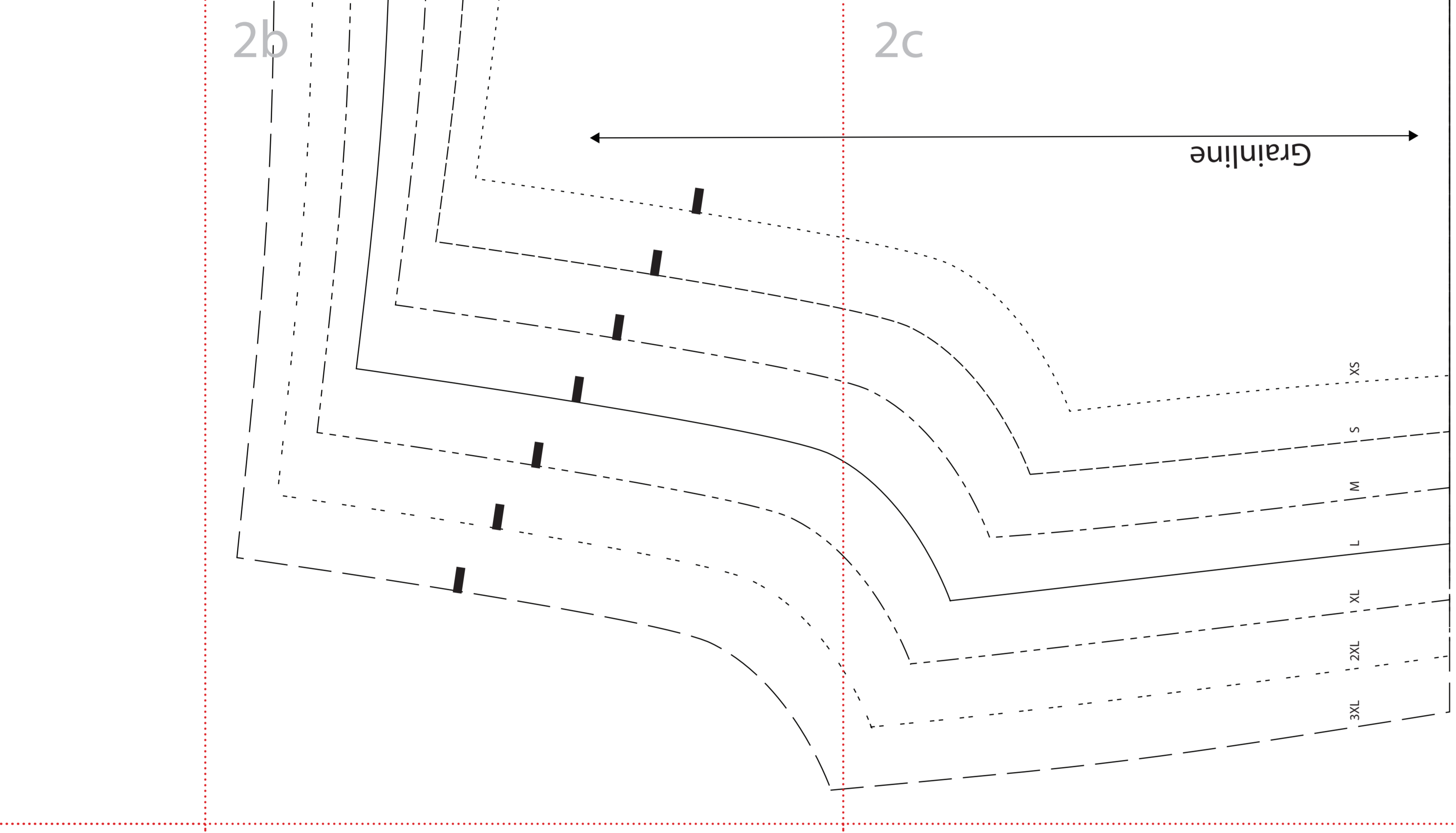
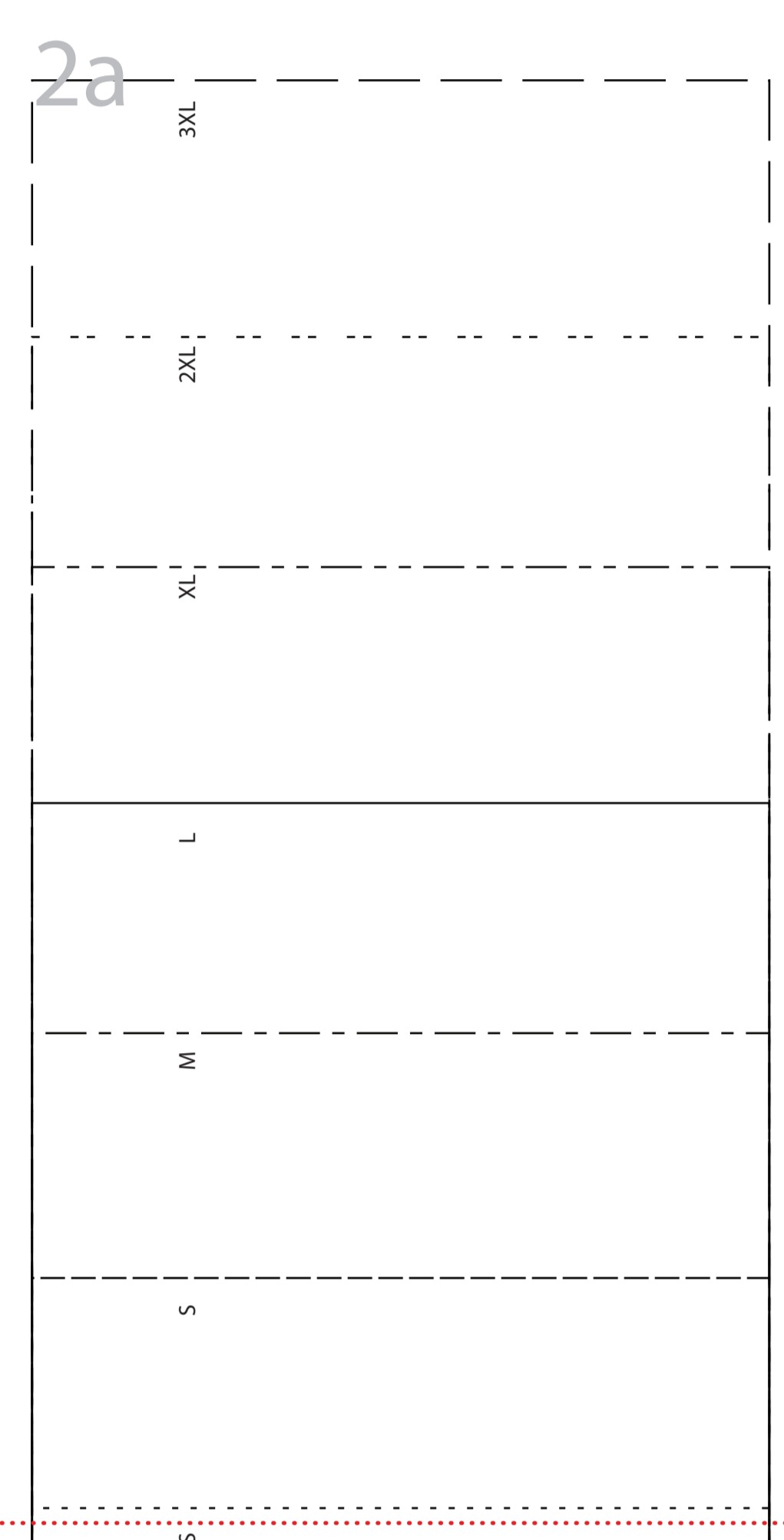
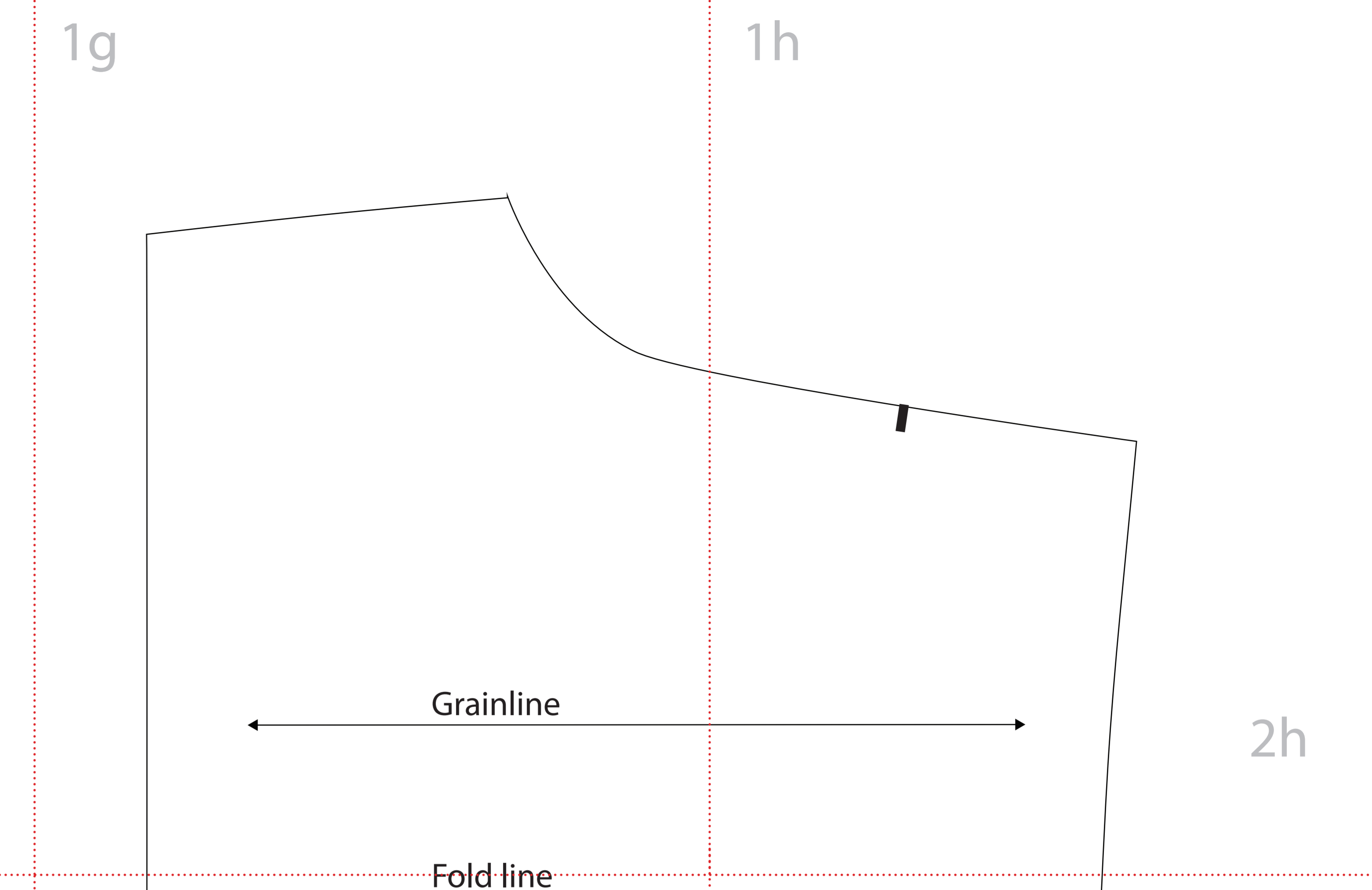
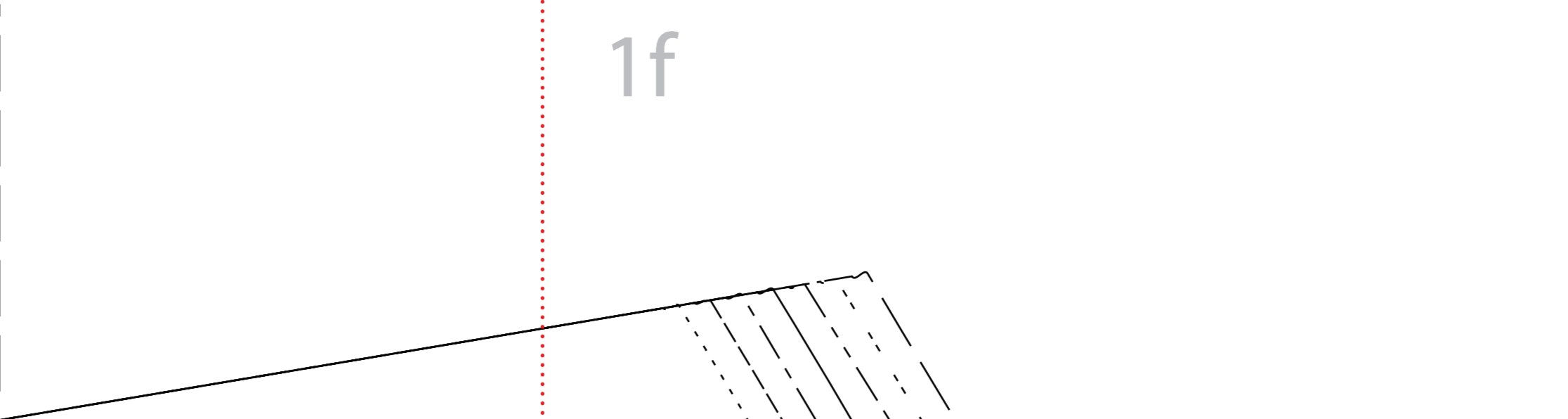
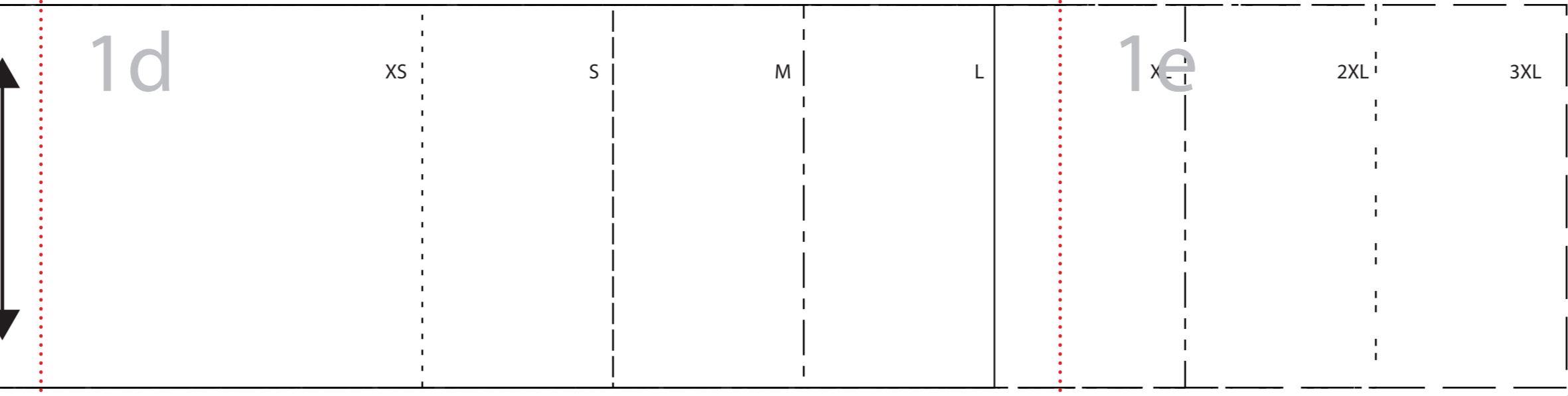
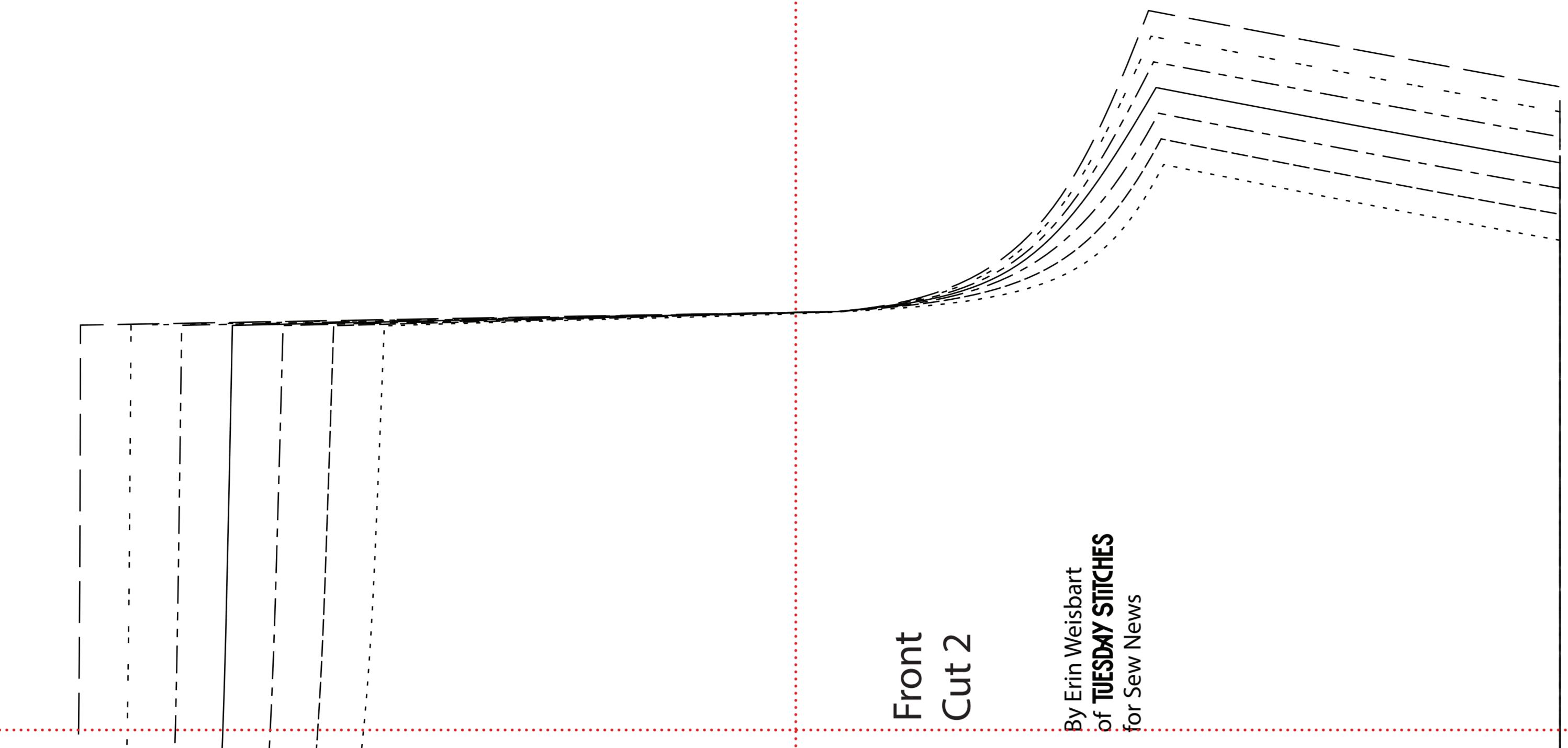

1a

SEW
NEWS
The Trusted Sewing Source

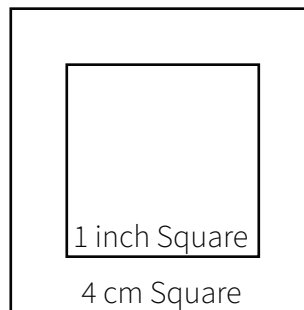

SHORELINE SHORTS

1b

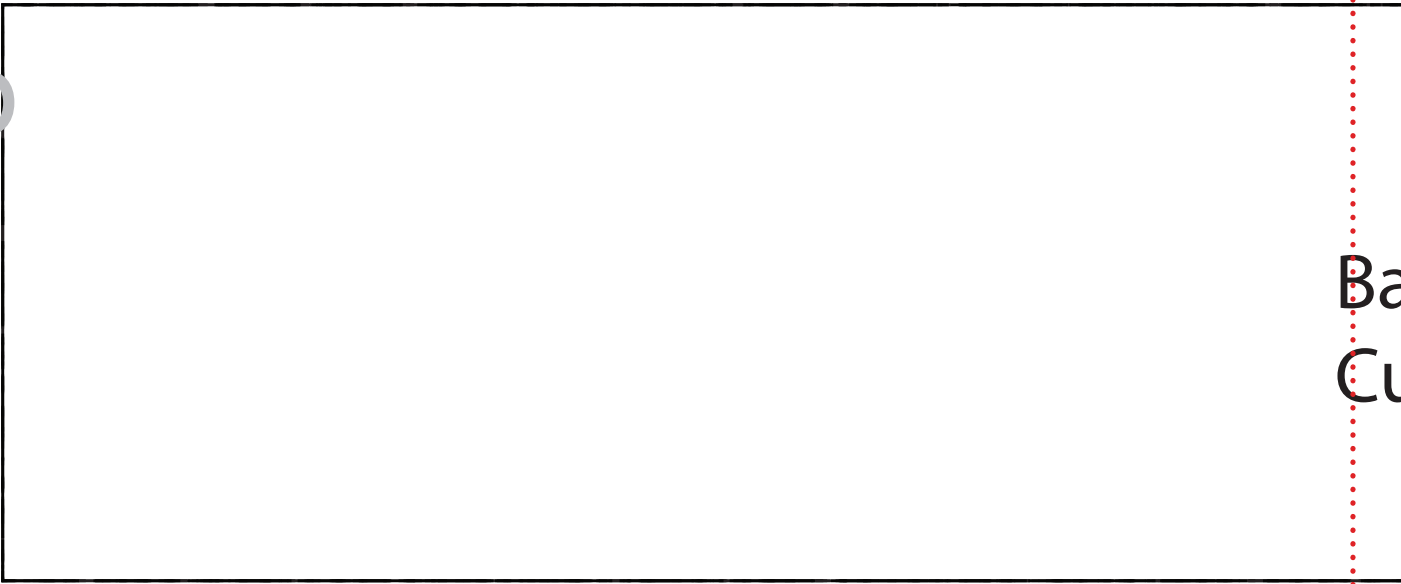

Ba
Cu

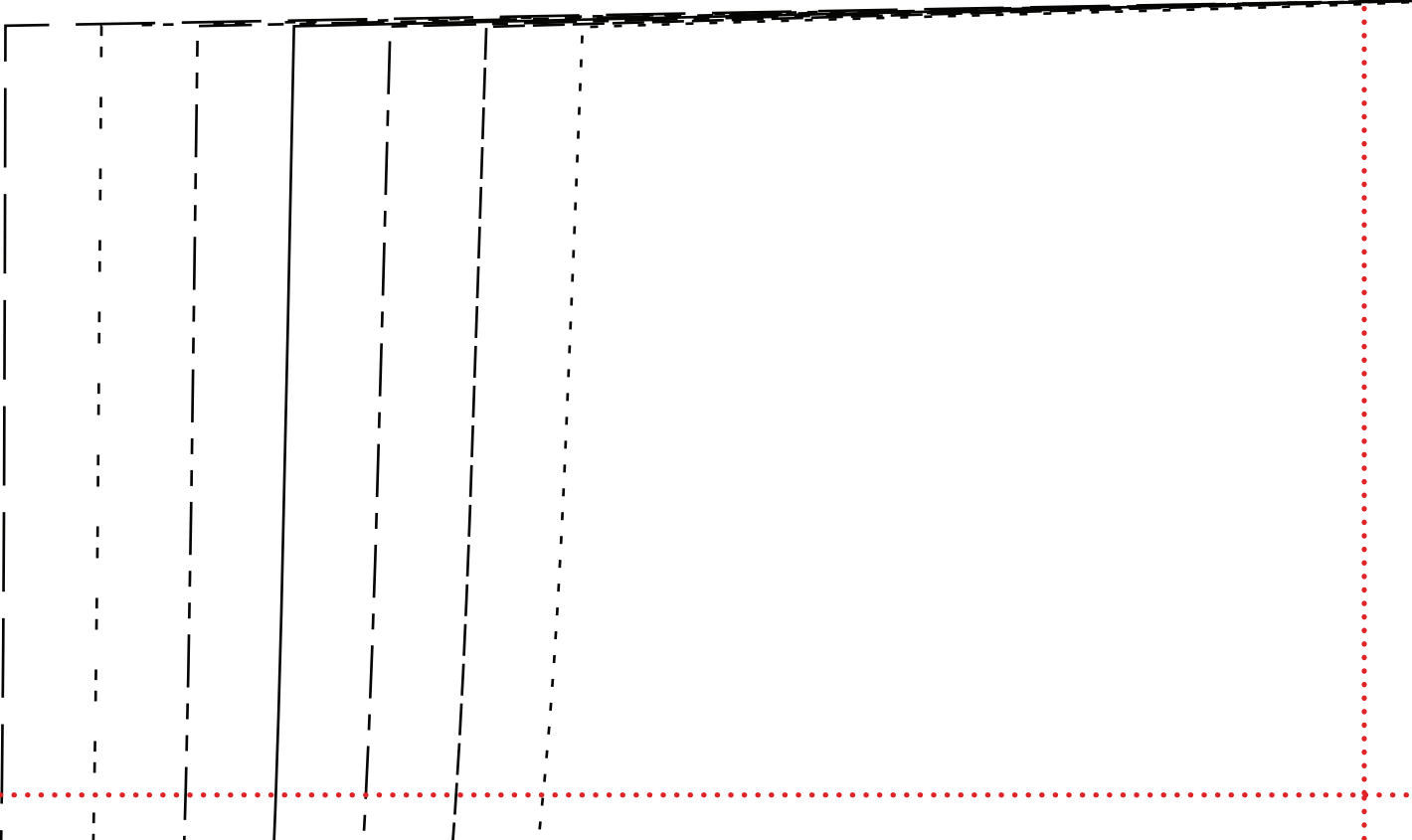

1c

Back Ruffle
Cut 2

By Erin Weisbart
of **TUESDAY STITCHES**
for Sew News

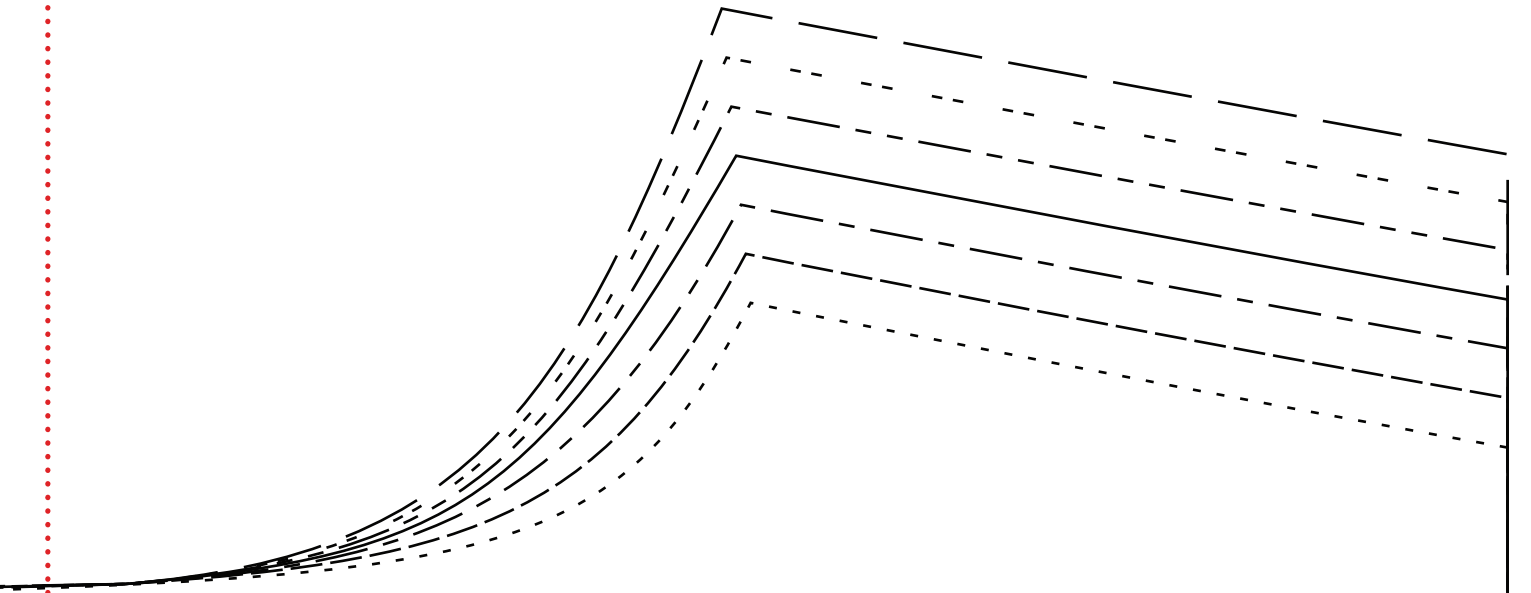

Front
Cut 2

By Erin Weisbart
of **TUESDAY STITCHES**
for Sew News

1d

XS

S

M

L

3XL

2XL

1X

1

M

S

SX



1e

x

2XL

3XL

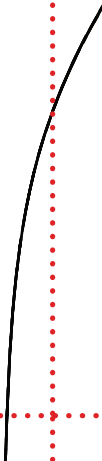
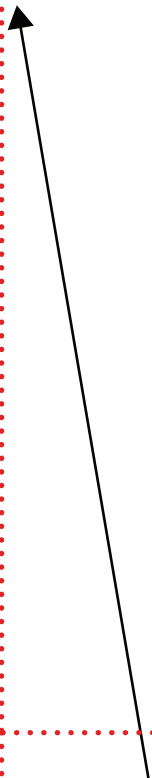

1f

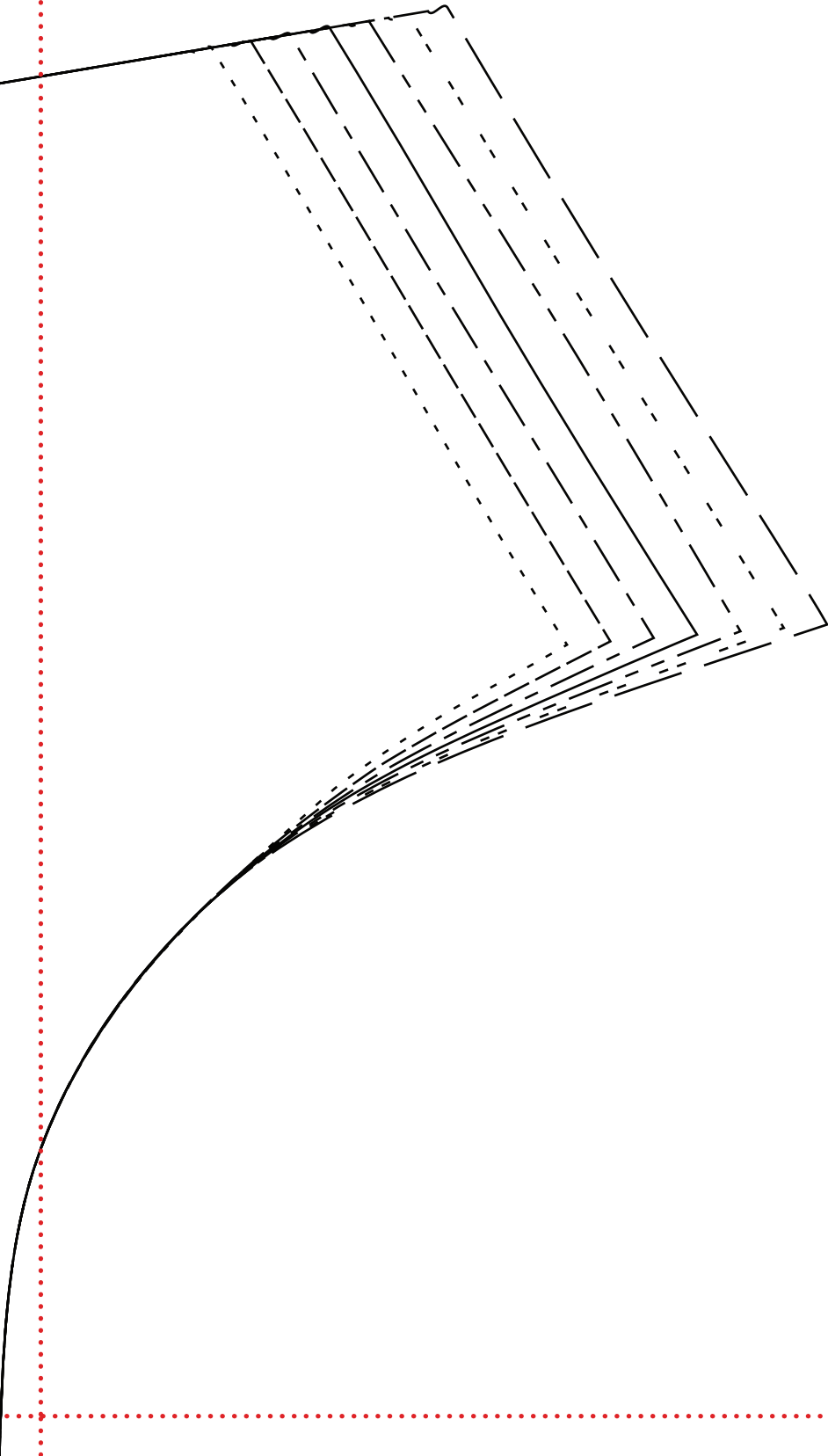

1g

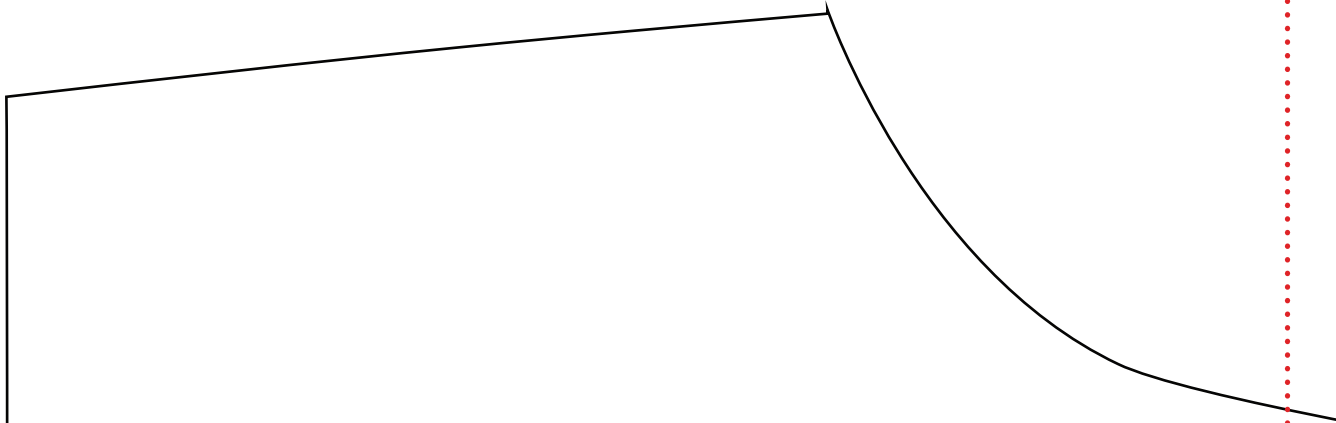

Grainline

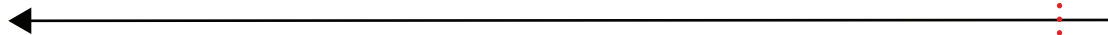

Fold line

1h

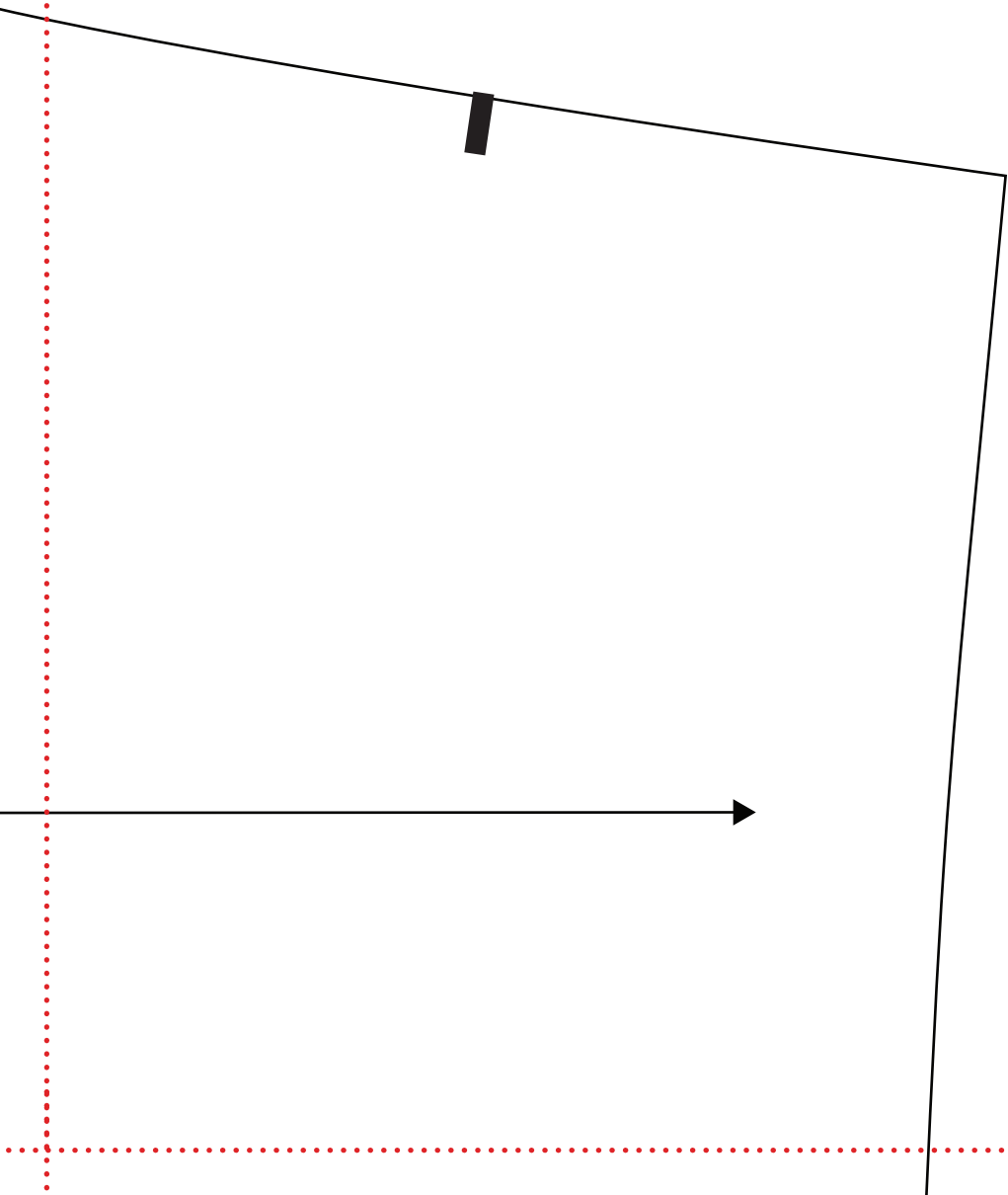

2h

2a

3XL

2XL

XL

L

M

S

XS

2b

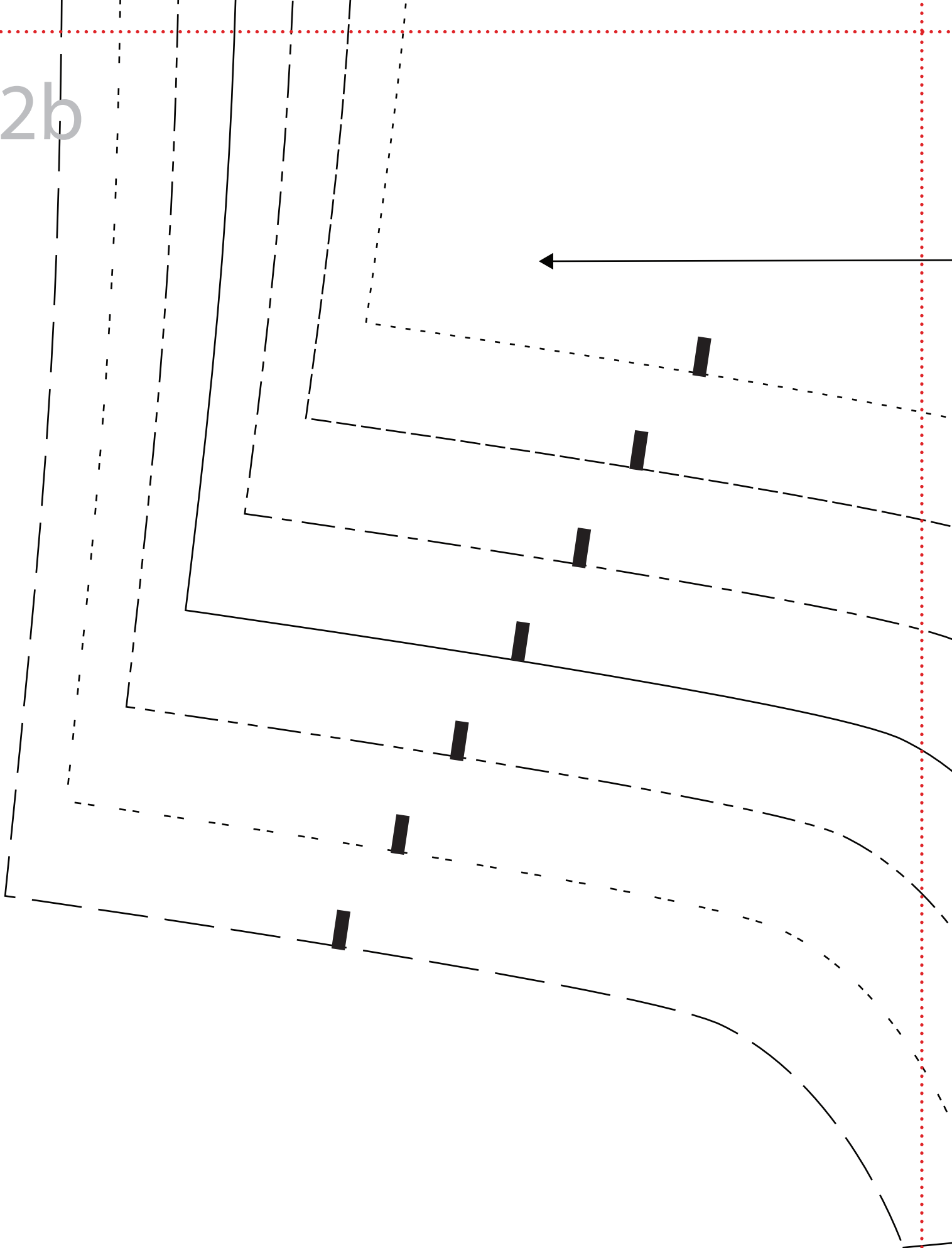

2c

Grainline

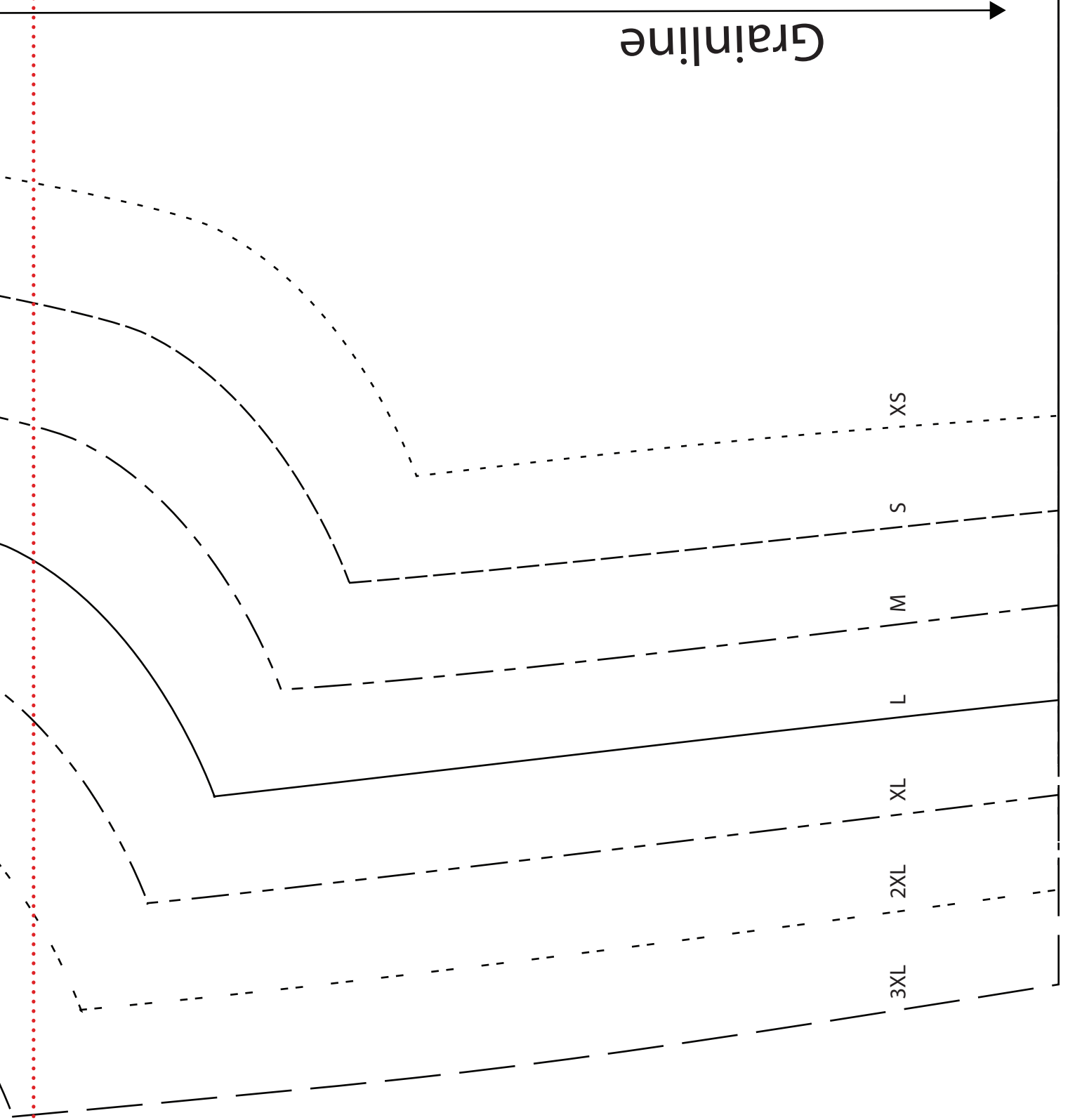

2d

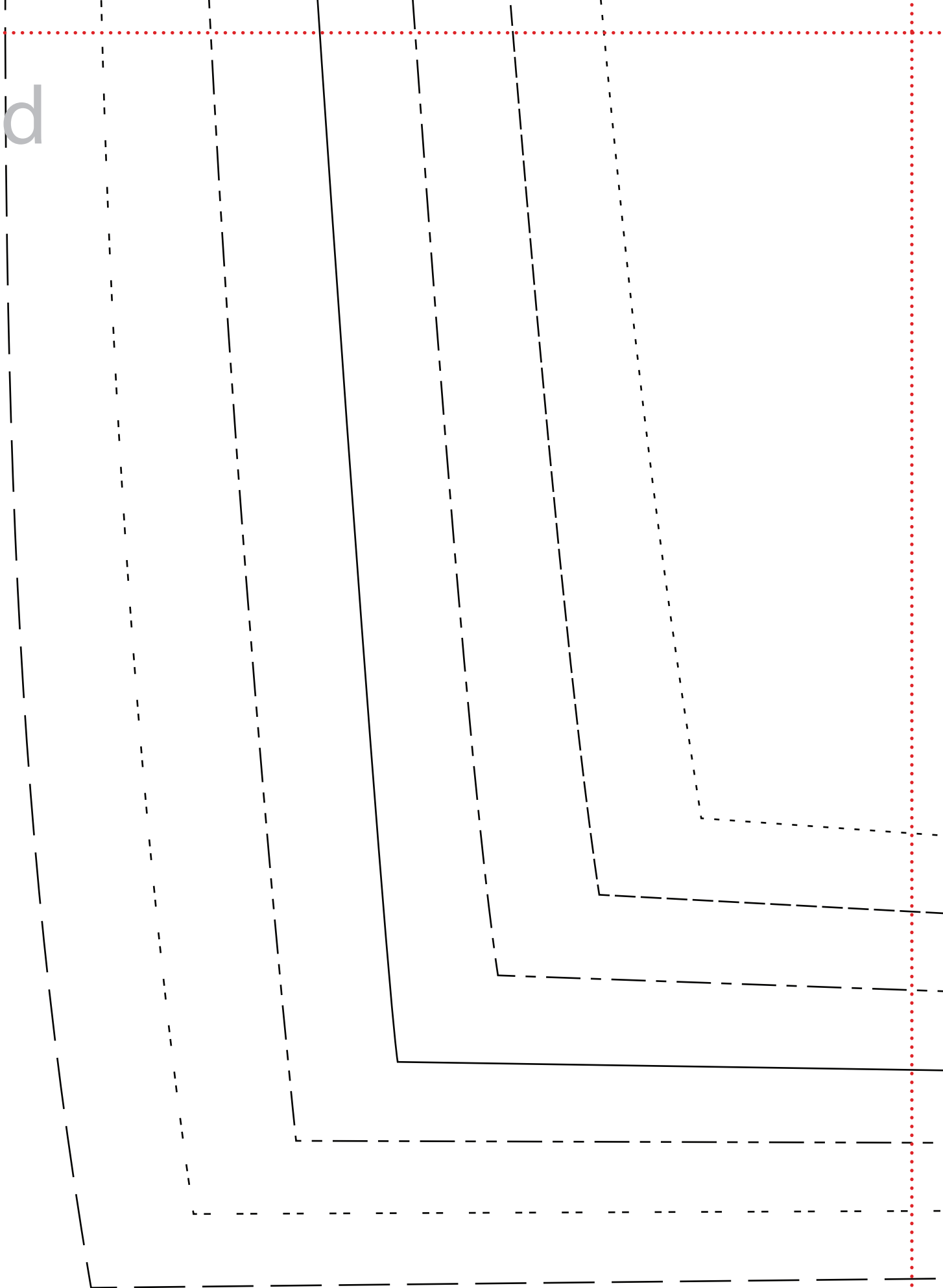

2e

By Erin Weisbart
of **TUESDAY STITCHES**
for Sew News

Back
Cut 2

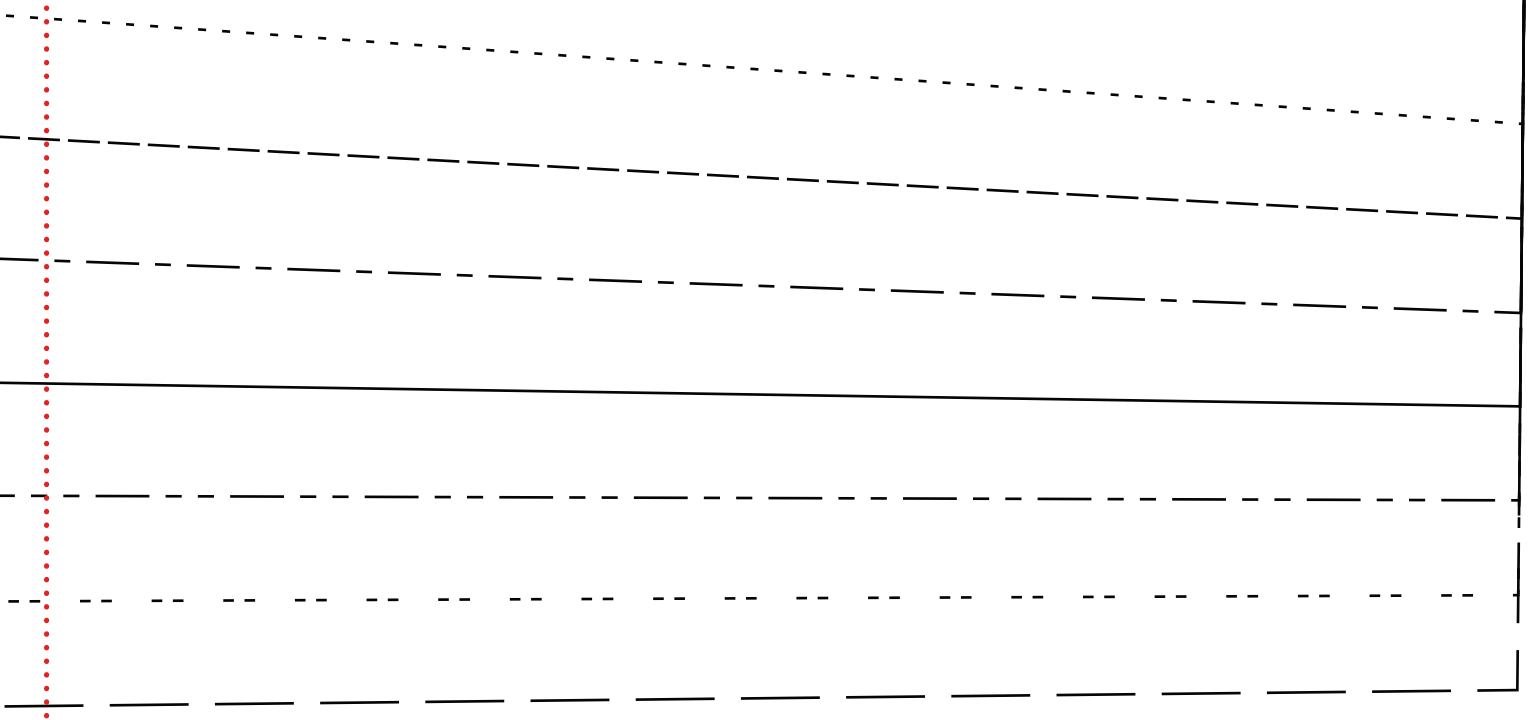

2f

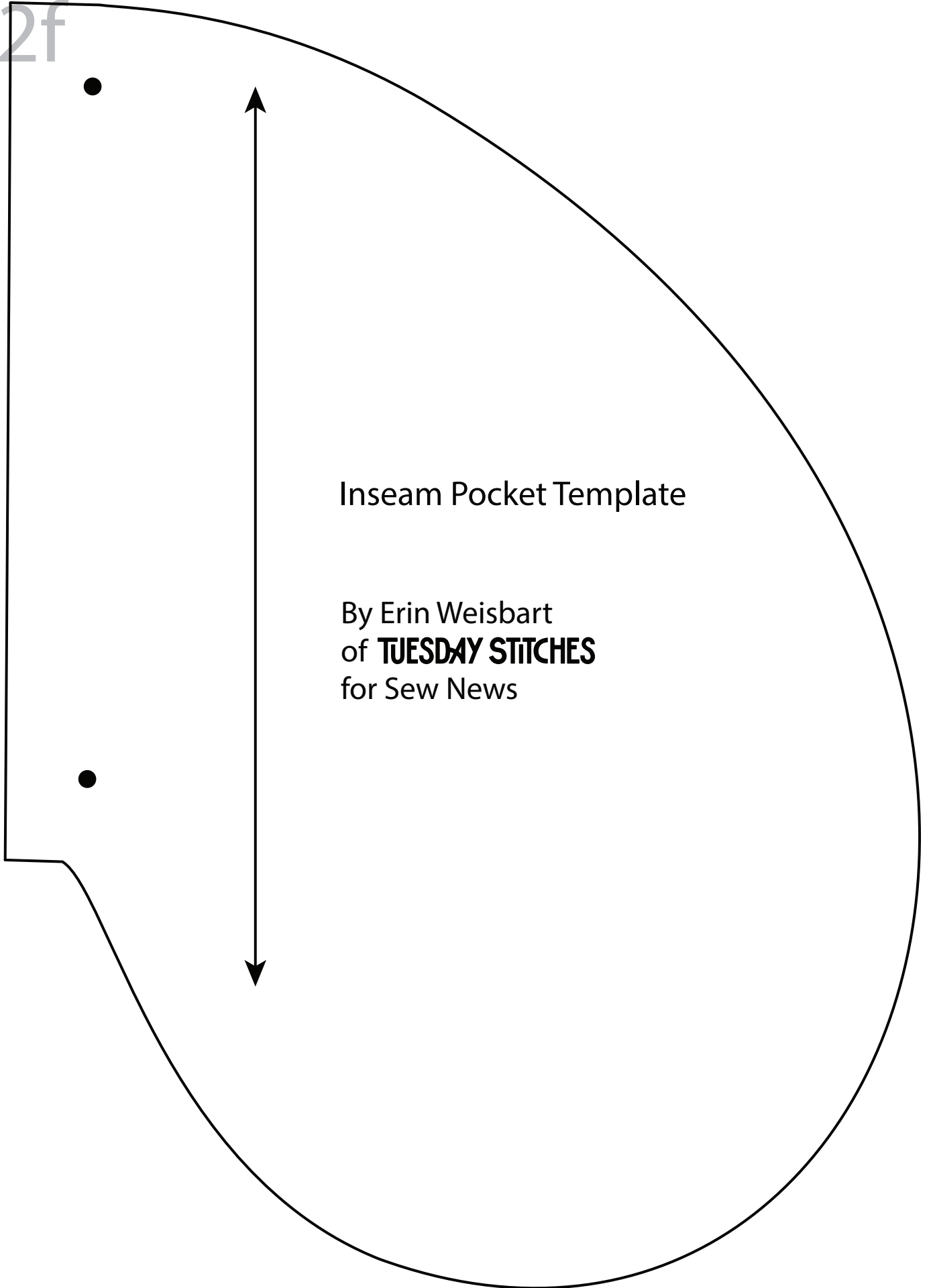

Inseam Pocket Template

By Erin Weisbart
of **TUESDAY STITCHES**
for Sew News

Fold line

2g

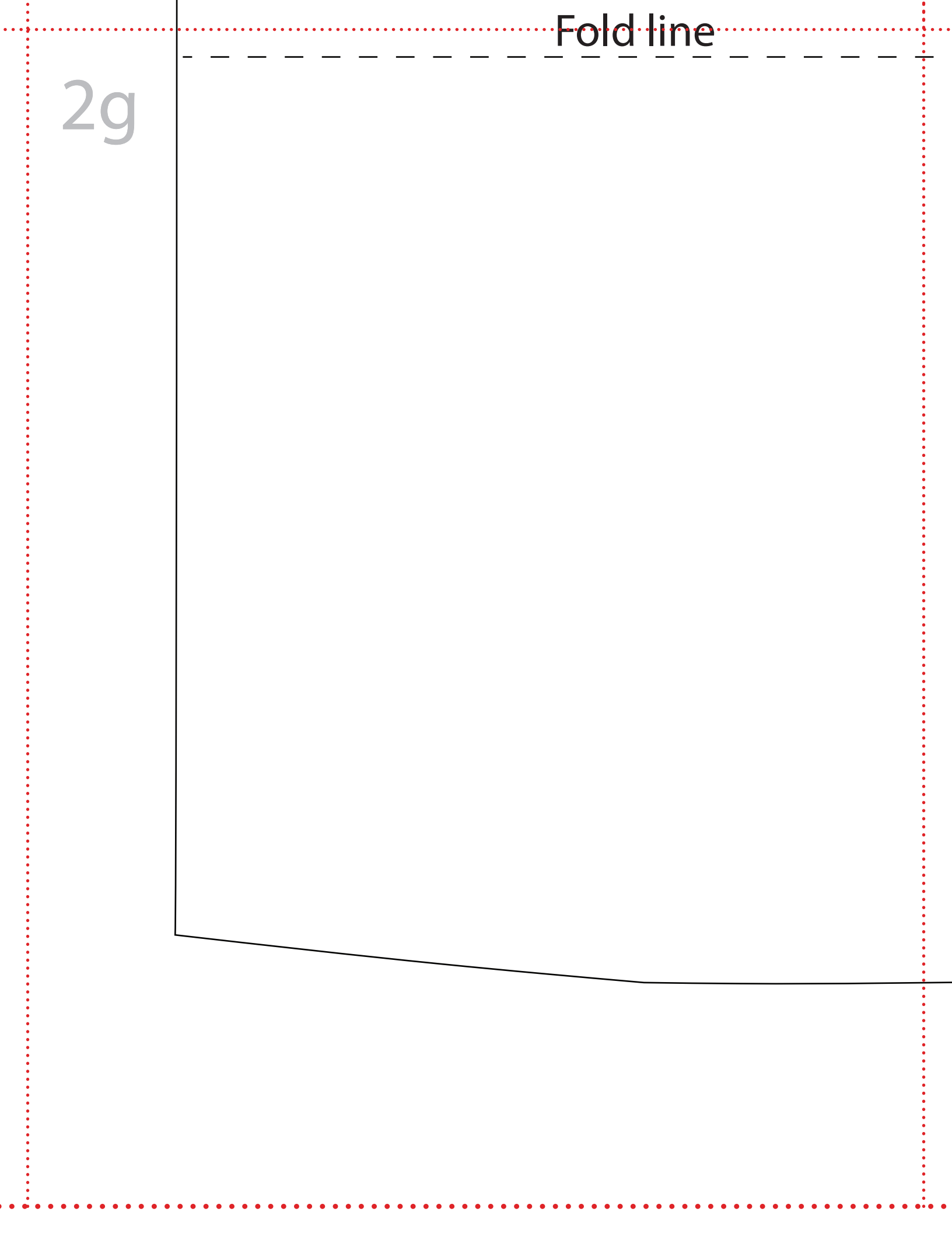
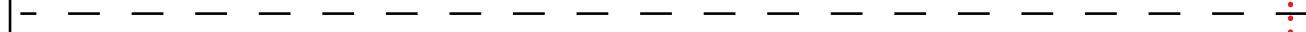



Pocket
Cut 2

By Erin Weisbart
of **TUESDAY STITCHES**
for Sew News

3a

XS



By Erin Weisbart
of **TUESDAY STITCHES**
for Sew News

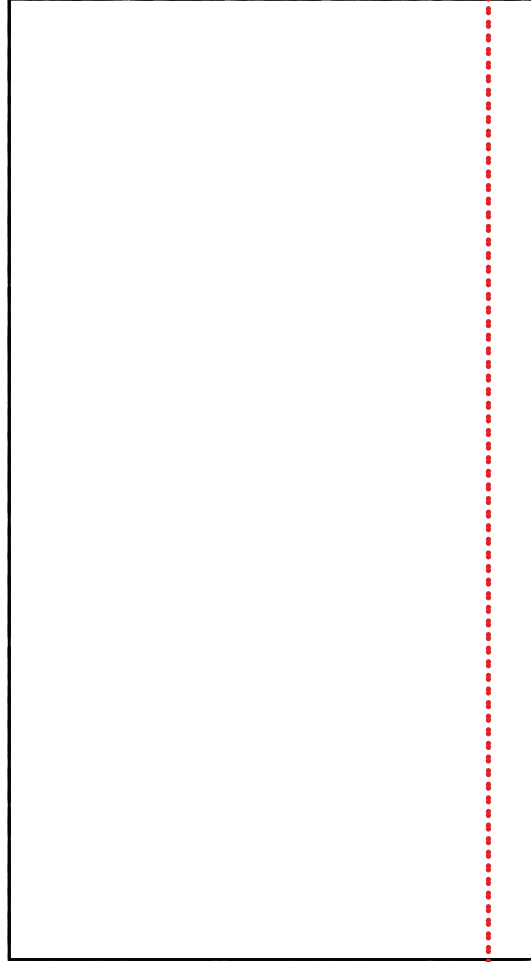
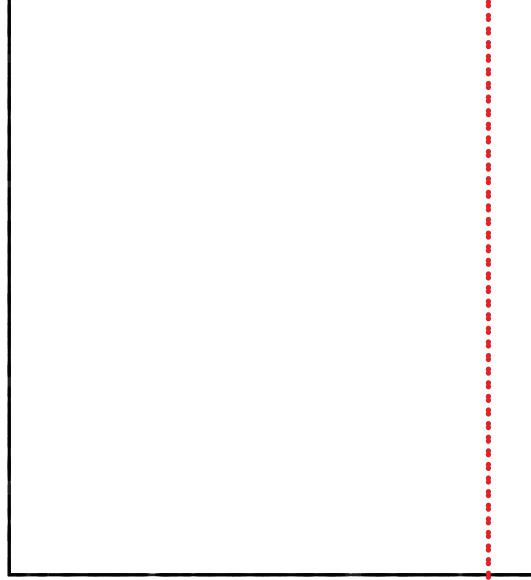

3b

Front Ruffle
Cut 2



By Erin Weisbart
of **TUESDAY STITCHES**
for Sew News

Front Waistband
Cut 2



By Erin Weisbart
of **TUESDAY STITCHES**
for Sew News

3c

XS

S

M

XS

S

M

L

XL

3d

L

XL

2XL

3XL

2XL

3XL

4a

Back Waistband
Cut 2